



## **SMT inductors**

SIMID series, SIMID 2220-A

**Series/Type:**            **B82442A**

**Date:**                    **March 2008**

SIMID 2220-A

SMD

Size 2220 (EIA) or 5650 (IEC)  
Rated inductance 1  $\mu\text{H}$  to 10000  $\mu\text{H}$   
Rated current 25 mA to 1800 mA



**Construction**

- Upright ferrite drum core
- Laser-welded winding
- Flame-retardant molding

**Features**

- Temperature range up to 150 °C
- Current handling capability up to 1.8 A
- High inductance ratings
- Qualified to AEC-Q200
- Suitable for lead-free reflow soldering as referenced in JEDEC J-STD 020C
- RoHS-compatible

**Applications**

- Filtering of supply voltages, coupling, decoupling
- DC/DC converters
- Automotive electronics
- Telecommunications  
(e.g. blocking filter for 12- and 16-kHz counting pulses)
- Consumer electronics
- Industrial electronics

**Terminals**

- Base material CuSn6
- Layer composition Cu, Ag, Sn (lead-free)<sup>1)</sup>
- Electro-plated

**Marking**

- Marking on component:  
Manufacturer, L value (in nH),  
tolerance of L value (coded), date of manufacture (YWWD)
- Minimum data on reel:  
Manufacturer, ordering code, L value, quantity, date of packing

**Delivery mode and packing unit**

- 12-mm blister tape, wound on 330-mm  $\varnothing$  reel
- Packing unit: 1500 pcs./reel

1) Ni-barrier-plated terminals on request (B82442A\*50).

**SIMID 2220-A**

**SMD**

**Dimensional drawing and layout recommendation**

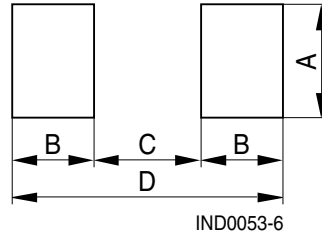
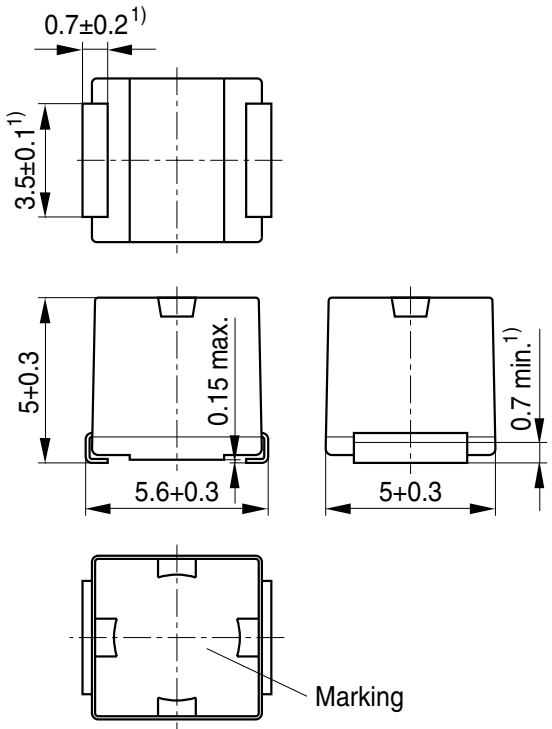

A	B	C	D
4.5	2.0	4.0	8.0

1) Soldering area

IND0088-3-E

Dimensions in mm

**Taping and packing**

Blister tape

Reel

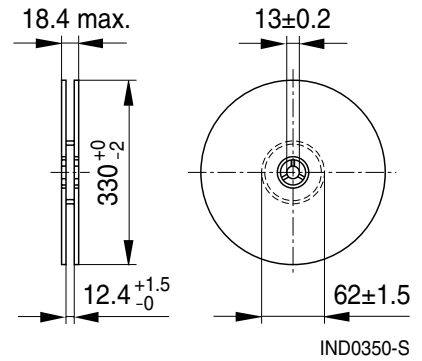
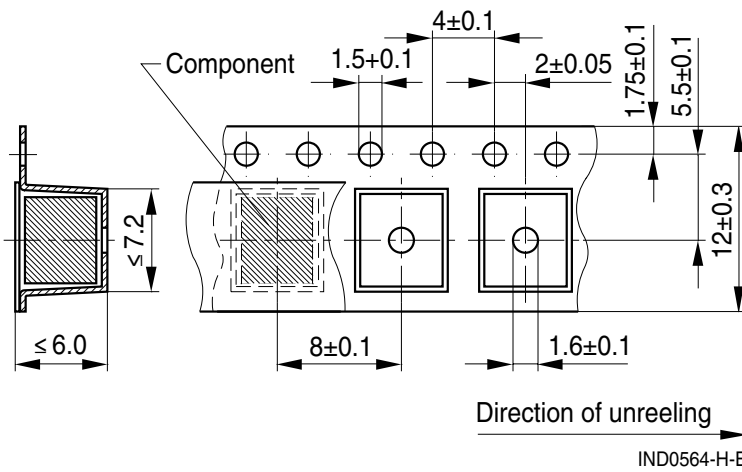

Dimensions in mm

**Technical data and measuring conditions**

Rated inductance $L_R$	Measured with impedance analyzer Agilent 4294A at frequency $f_L$ , 0.1 V, 20 °C
Q factor $Q_{\min}$	Measured with impedance analyzer Agilent 4294A at frequency $f_Q$ , 20 °C
Rated temperature $T_R$	105 °C
Rated current $I_R$	Maximum permissible DC with inductance decrease $\Delta L/L_0 \leq 10\%$ and temperature increase of $\leq 20$ K at rated temperature
Self-resonance frequency $f_{\text{res,min}}$	Measured with network analyzer Agilent 8753D, 20 °C
DC resistance $R_{\text{max}}$	Measured at 20 °C
Solderability (lead-free)	Sn95.5Ag3.8Cu0.7: (245 ±5) °C, (5 ±0.3) s Wetting of soldering area $\geq 90\%$ (based on IEC 60068-2-58)
Resistance to soldering heat	260 °C, 40 s (as referenced in JEDEC J-STD 020C)
Climatic category	55/150/56 (to IEC 60068-1)
Storage conditions	Mounted: -55 °C ... +150 °C Packaged: -25 °C ... +40 °C, $\leq 75\%$ RH
Weight	Approx. 0.4 g

**Characteristics and ordering codes**

$L_R$ $\mu\text{H}$	Tolerance	$Q_{\min}$	$f_L; f_Q$ MHz	$I_R$ mA	$R_{\max}$ $\Omega$	$f_{\text{res,min}}$ MHz	Ordering code <sup>1)2)</sup>
1.0	$\pm 10\% \triangleq K$	10	7.96	1800	0.024	95	B82442A1102K000
1.2		10	7.96	1700	0.028	70	B82442A1122K000
1.5		10	7.96	1600	0.032	55	B82442A1152K000
1.8		10	7.96	1400	0.040	47	B82442A1182K000
2.2		10	7.96	1300	0.048	42	B82442A1222K000
2.7		10	7.96	1200	0.056	37	B82442A1272K000
3.3		10	7.96	1120	0.064	34	B82442A1332K000
3.9		10	7.96	1050	0.072	32	B82442A1392K000
4.7		10	7.96	950	0.088	29	B82442A1472K000
5.6		10	7.96	880	0.104	26	B82442A1562K000
6.8		10	7.96	810	0.120	24	B82442A1682K000
8.2		10	7.96	750	0.144	22	B82442A1822K000
10		10	2.52	690	0.168	19	B82442A1103K000
12		10	2.52	630	0.20	17	B82442A1123K000
15		10	2.52	580	0.24	16	B82442A1153K000
18	10	2.52	530	0.29	14	B82442A1183K000	
22	10	2.52	480	0.35	13	B82442A1223K000	
27	10	2.52	440	0.42	11.5	B82442A1273K000	
33	$\pm 5\% \triangleq J$	10	2.52	400	0.50	10.5	B82442A1333+000
39	$\pm 10\% \triangleq K$	10	2.52	370	0.58	9.5	B82442A1393+000
47		10	2.52	340	0.68	8.5	B82442A1473+000
56		10	2.52	310	0.80	7.8	B82442A1563+000
68	10	2.52	290	0.96	7.0	B82442A1683+000	
82	10	2.52	270	1.12	6.4	B82442A1823+000	
100		20	0.796	250	1.28	6.0	B82442A1104+000
120		20	0.796	230	1.52	5.4	B82442A1124+000
150		20	0.796	210	1.76	4.8	B82442A1154+000
180		20	0.796	190	2.24	4.4	B82442A1184+000

Closer tolerances on request.

Higher currents possible at temperatures  $< T_R$  on request.

Sample kit available. Ordering code: B82442X001

For more information refer to chapter "Sample kits".

1) Replace the + by the code letter for the required inductance tolerance.

2) For Ni-barrier-plated terminals replace the last two digits "00" by "50".

**Characteristics and ordering codes**

$L_R$ $\mu\text{H}$	Tolerance	$Q_{\min}$	$f_L; f_Q$ MHz	$I_R$ mA	$R_{\max}$ $\Omega$	$f_{\text{res,min}}$ MHz	Ordering code <sup>1)2)</sup>
220	$\pm 5\% \triangle J$	20	0.796	170	2.72	3.9	B82442A1224+000
270	$\pm 10\% \triangle K$	20	0.796	155	3.36	3.6	B82442A1274+000
330		20	0.796	140	3.92	3.2	B82442A1334+000
390	$\pm 10\% \triangle K$	20	0.796	130	4.64	2.9	B82442A1394+000
470		20	0.796	120	5.60	2.6	B82442A1474+000
560		20	0.796	110	6.80	2.4	B82442A1564+000
680		20	0.796	100	8.00	2.2	B82442A1684+000
820		20	0.796	90	10.4	2.0	B82442A1824+000
1000		30	0.252	85	12.0	1.8	B82442A1105+000
1200	$\pm 10\% \triangle K$	30	0.252	75	13.6	1.5	B82442A1125+000
1500		30	0.252	70	16.0	1.4	B82442A1155+000
1800		30	0.252	60	24.0	1.3	B82442A1185+000
2200	$\pm 10\% \triangle K$	30	0.252	55	28.0	1.2	B82442A1225+000
2700		30	0.252	45	44.0	1.1	B82442A1275+000
3300		30	0.252	40	48.0	1.0	B82442A1335+000
3900	$\pm 10\% \triangle K$	30	0.252	38	56.0	1.0	B82442A1395+000
4700		30	0.252	36	62.4	0.9	B82442A1475+000
5600		30	0.252	33	68.0	0.8	B82442A1565+000
6800	$\pm 10\% \triangle K$	30	0.252	30	88.0	0.7	B82442A1685+000
8200		30	0.252	28	100	0.6	B82442A1825+000
10000		30	0.0796	25	120	0.5	B82442A1106+000

For telecommunications in blocking filter for 12- and 16-kHz counting pulses

980	$\pm 3\% \triangle A$	8	0.016	85	15	1.8	B82442A1984A000
1450		8	0.016	70	20	1.4	B82442A1145A500
2600		6	0.012	45	43	1.1	B82442A1265A000
3050		8	0.016	45	45	0.9	B82442A1305A500
5330		6	0.012	34	66	0.8	B82442A1535A300

Closer tolerances on request.

Higher currents possible at temperatures  $< T_R$  on request.

Sample kit available. Ordering code: B82442X001

For more information refer to chapter "Sample kits".

1) Replace the + by the code letter for the required inductance tolerance.

2) For Ni-barrier-plated terminals replace the last two digits "00" by "50".

**SMD**

**Impedance  $|Z|$  versus frequency  $f$**   
measured with impedance analyzer  
Agilent 4191A/4194A, typical values at 20 °C

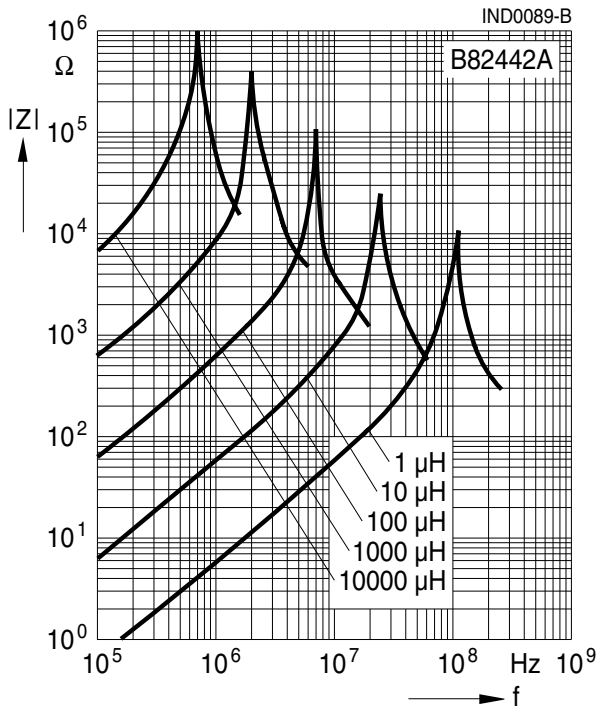

**Inductance  $L$  versus DC load current  $I_{DC}$**   
measured with LCR meter Agilent 4275A,  
typical values at 20 °C

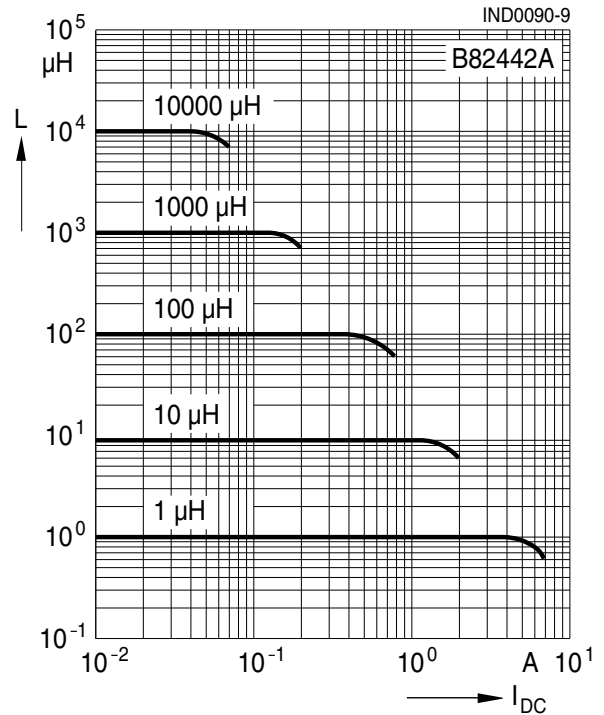

**Q factor versus frequency  $f$**   
measured with impedance analyzer  
Agilent 4191A/4194A, typical values at 20 °C

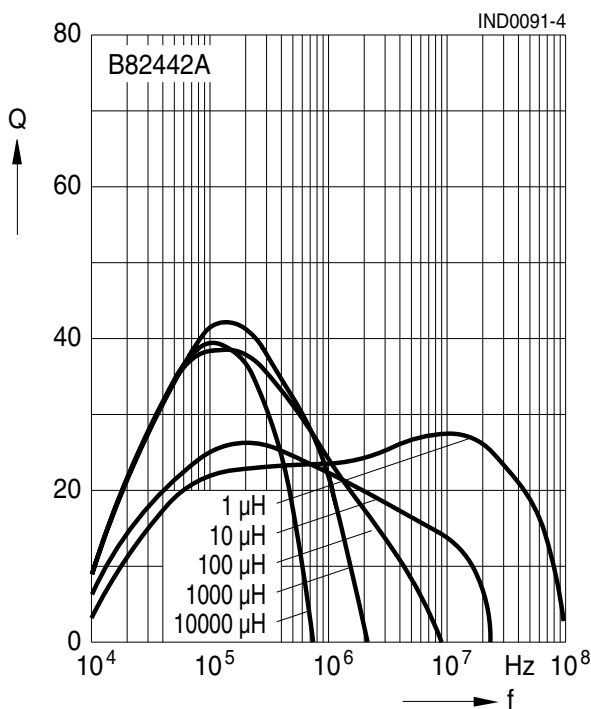

**Current derating  $I_{op}/I_R$**   
**versus ambient temperature  $T_A$**   
(rated temperature  $T_R = 105$  °C)

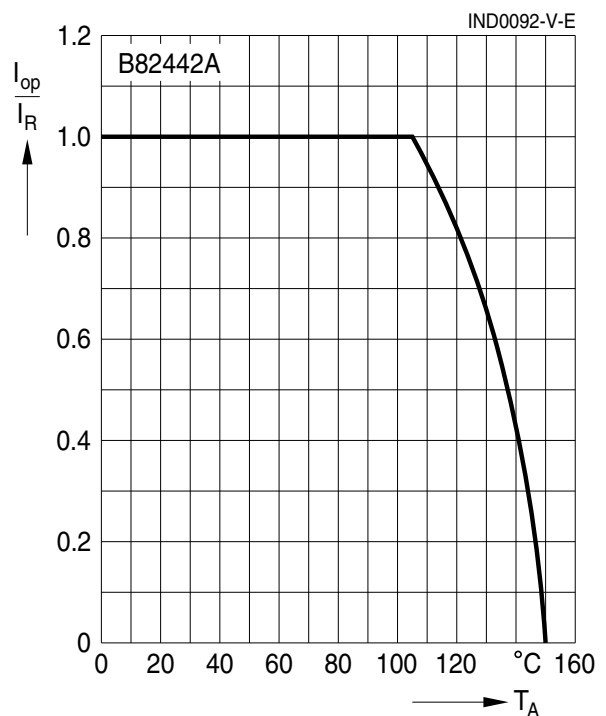

## Cautions and warnings

- Please note the recommendations in our Inductors data book (latest edition) and in the data sheets.
  - Particular attention should be paid to the derating curves given there.
  - The soldering conditions should also be observed. Temperatures quoted in relation to wave soldering refer to the pin, not the housing.
- If the components are to be washed and varnished it is necessary to check whether the washing varnish agent that is used has a negative effect on the wire insulation, any plastics that are used, or on glued joints. In particular, it is possible for washing varnish agent residues to have a negative effect in the long-term on wire insulation.
- The following points must be observed if the components are potted in customer applications:
  - Many potting materials shrink as they harden. They therefore exert a pressure on the plastic housing or core. This pressure can have a deleterious effect on electrical properties, and in extreme cases can damage the core or plastic housing mechanically.
  - It is necessary to check whether the potting material used attacks or destroys the wire insulation, plastics or glue.
  - The effect of the potting material can change the high-frequency behaviour of the components.
- Ferrites are sensitive to direct impact. This can cause the core material to flake, or lead to breakage of the core.
- Even for customer-specific products, conclusive validation of the component in the circuit can only be carried out by the customer.



## Important notes

The following applies to all products named in this publication:

1. Some parts of this publication contain **statements about the suitability of our products for certain areas of application**. These statements are based on our knowledge of typical requirements that are often placed on our products in the areas of application concerned. We nevertheless expressly point out **that such statements cannot be regarded as binding statements about the suitability of our products for a particular customer application**.

As a rule, EPCOS is either unfamiliar with individual customer applications or less familiar with them than the customers themselves. For these reasons, it is always ultimately incumbent on the customer to check and decide whether an EPCOS product with the properties described in the product specification is suitable for use in a particular customer application.

2. We also point out that **in individual cases, a malfunction of electronic components or failure before the end of their usual service life cannot be completely ruled out in the current state of the art, even if they are operated as specified**. In customer applications requiring a very high level of operational safety and especially in customer applications in which the malfunction or failure of an electronic component could endanger human life or health (e.g. in accident prevention or life-saving systems), it must therefore be ensured by means of suitable design of the customer application or other action taken by the customer (e.g. in installation of protective circuitry or redundancy) that no injury or damage is sustained by third parties in the event of malfunction or failure of an electronic component.
3. **The warnings, cautions and product-specific notes must be observed.**
4. In order to satisfy certain technical requirements, **some of the products described in this publication may contain substances subject to restrictions in certain jurisdictions (e.g. because they are classed as hazardous)**. Useful information on this will be found in our Material Data Sheets on the Internet ([www.epcos.com/material](http://www.epcos.com/material)). Should you have any more detailed questions, please contact our sales offices.
5. We constantly strive to improve our products. Consequently, **the products described in this publication may change from time to time**. The same is true of the corresponding product specifications. Please check therefore to what extent product descriptions and specifications contained in this publication are still applicable before or when you place an order.

We also **reserve the right to discontinue production and delivery of products**. Consequently, we can not guarantee that all products named in this publication will always be available.

The aforementioned does not apply in the case of individual agreements deviating from the foregoing for customer-specific products.

6. Unless otherwise agreed in individual contracts, **all orders are subject to the current version of the “General Terms of Delivery for Products and Services in the Electrical Industry” published by the German Electrical and Electronics Industry Association (ZVEI)**.
7. The trade names EPCOS, BAOKE, Alu-X, CeraDiode, CSMP, CSSP, CTVS, DSSP, MiniBlue, MKK, MLSC, MotorCap, PCC, PhaseCap, PhaseCube, PhaseMod, SIFERRIT, SIFI, SIKOREL, SilverCap, SIMDAD, SIMID, SineFormer, SIOV, SIP5D, SIP5K, ThermoFuse, WindCap are **trademarks registered or pending** in Europe and in other countries. Further information will be found on the Internet at [www.epcos.com/trademarks](http://www.epcos.com/trademarks).